



# DB-54003L-880

## RF POWER AMPLIFIER USING 1 x PD54003L

PRELIMINARY DATA

N-CHANNEL ENHANCEMENT-MODE LATERAL MOSFETs

### GENERAL FEATURES

- EXCELLENT THERMAL STABILITY
- FREQUENCY 800 - 880 MHz
- SUPPLY VOLTAGE 7.5 V
- OUTPUT POWER 2.5 W
- POWER GAIN 12.1 +/- 0.8 dB
- EFFICIENCY 53% - 60%
- LOAD MISMATCH 20:1
- BeO FREE AMPLIFIER

### DESCRIPTION

The DB-54003L-880 is a common source N-Channel Enhancement-Mode Lateral Field Effect RF power amplifier designed for 800 MHz portable radios.

Figure 1. Demo Board (Picture)

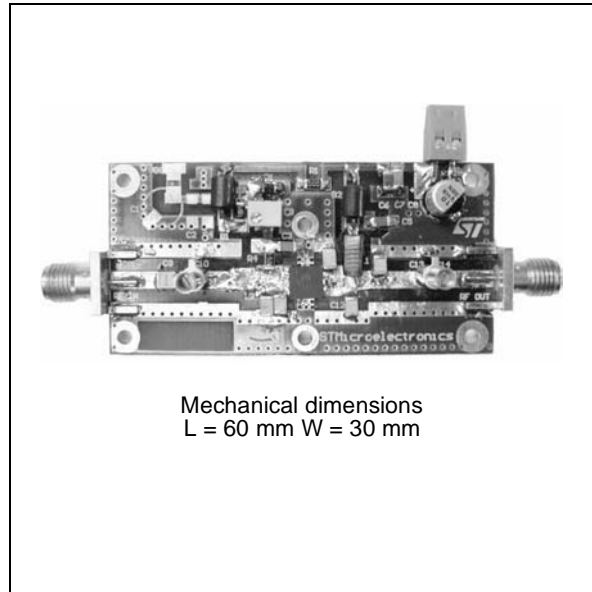

Mechanical dimensions  
L = 60 mm W = 30 mm

Table 1. Order Codes

Package	Order Code
PowerFLAT™ (5x5)	DB-54003L-880

Table 2. Absolute Maximum Ratings

Symbol	Parameter	Value	Unit
V <sub>DD</sub>	Supply voltage	16	V
I <sub>D</sub>	Drain current	1.3	A
P <sub>DISS</sub>	Power Dissipation	6	W
T <sub>CASE</sub>	Operate Case Temperature	-20 to +85	°C
T <sub>amb</sub>	Max. Ambient Temperature	55	°C

**ELECTRICAL CHARACTERISTICS**

( $T_{amb} = +25\text{ }^{\circ}\text{C}$ ,  $V_{DD} = 7.5\text{ V}$ ,  $I_{DQ} = 50\text{ mA}$ , unless otherwise specified)

**Table 3. RF Data**

Symbol	Parameters	Test Conditions	Min.	Typ.	Max.	Unit
f	Frequency range		800		880	MHz
$P_{out}$	Output Power		2.5	3		W
$G_p$	Power Gain	$P_{OUT} = 2.5\text{ W}$		12.1		dB
$N_D$	Efficiency	$P_{OUT} = 2.5\text{ W}$	53			%
	Gain Flatness	$P_{OUT} = 2.5\text{ W}$			+/- 0.8	dB
H2	2nd Harmonic	$P_{OUT} = 2.5\text{ W}$			-15	dBc
H3	3rd Harmonic	$P_{OUT} = 2.5\text{ W}$			-25	dBc
VSWR	Load Mismatch	$P_{OUT} = 2.5\text{ W}$ , all phases		20:1		

**Figure 2. Impedance data**

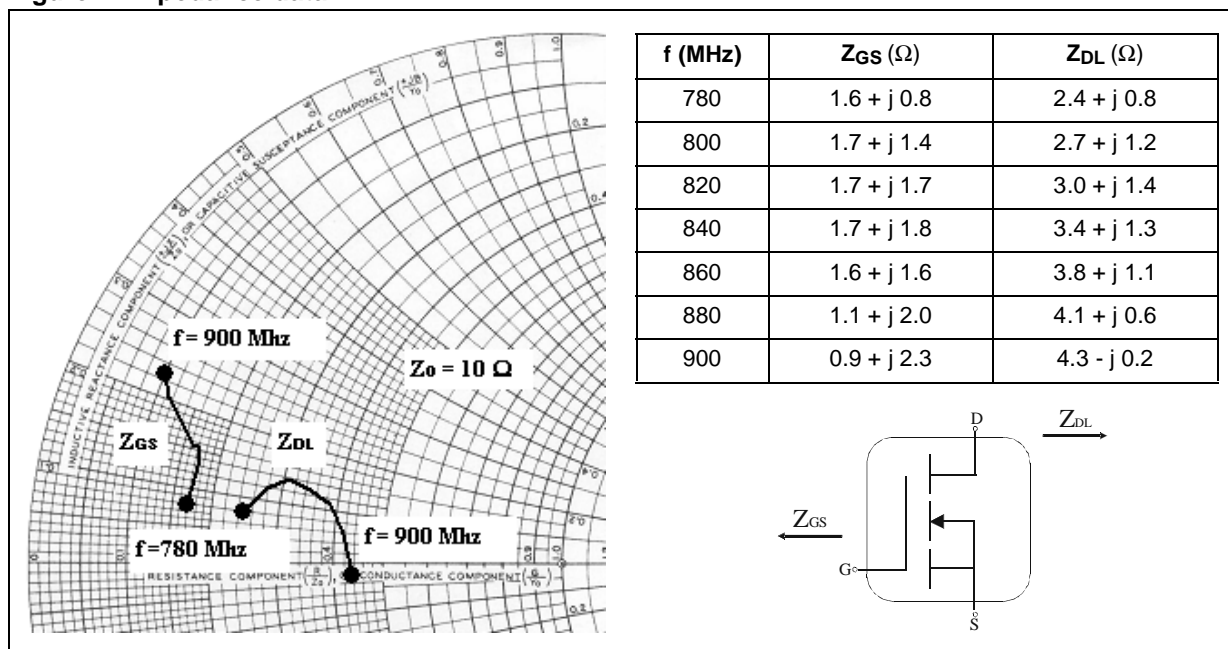

Note: Optimum board impedances into which the DUT operates, at a given DC bias and frequency band, to fulfill application requirements.

TYPICAL PERFORMANCE

Figure 3. Output Power Vs Input Power

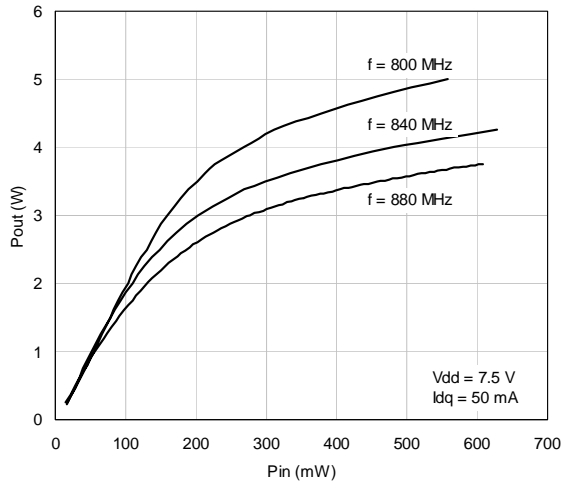

Figure 6. Efficiency Vs Output Power

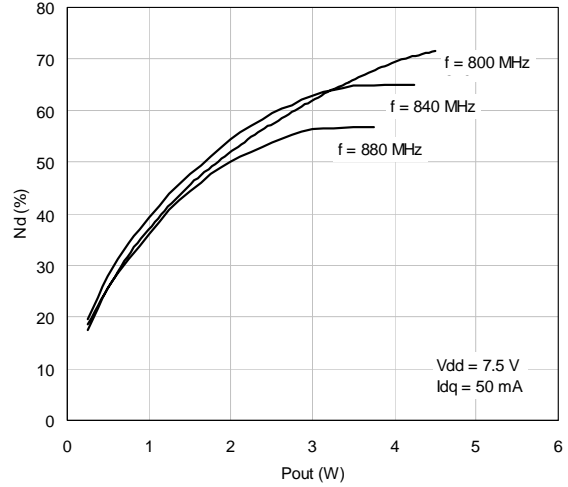

Figure 4. Power Gain Vs Output Power

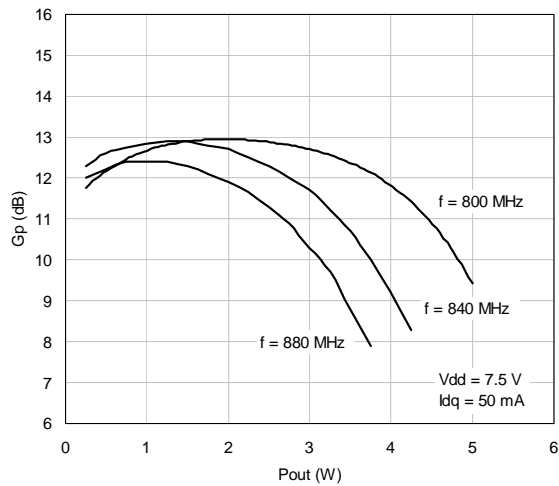

Figure 7. Pow. Gain & Efficiency Vs Frequency

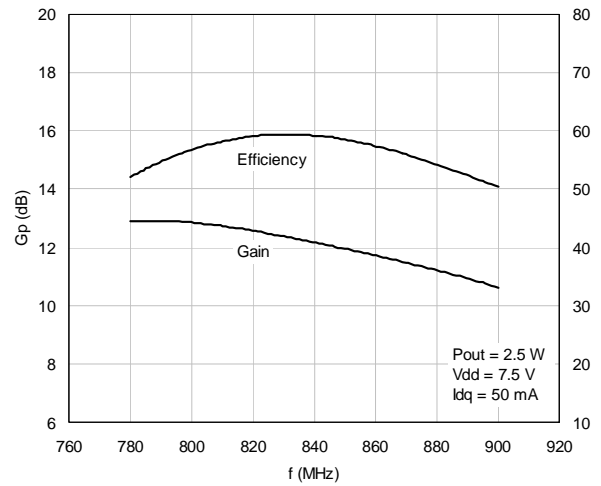

Figure 5. Input Return Loss Vs Frequency

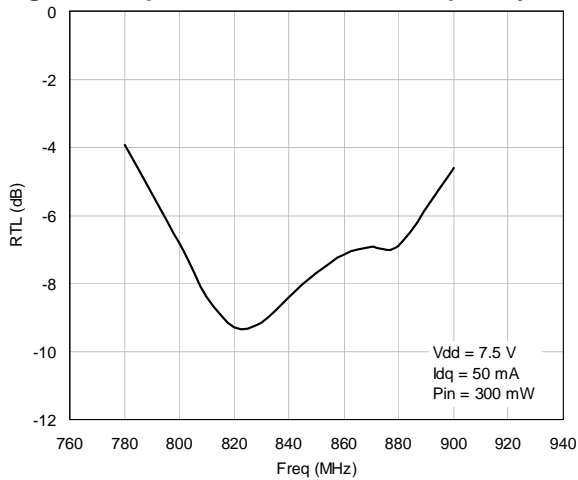

Figure 8. Output Power Vs Supply Voltage

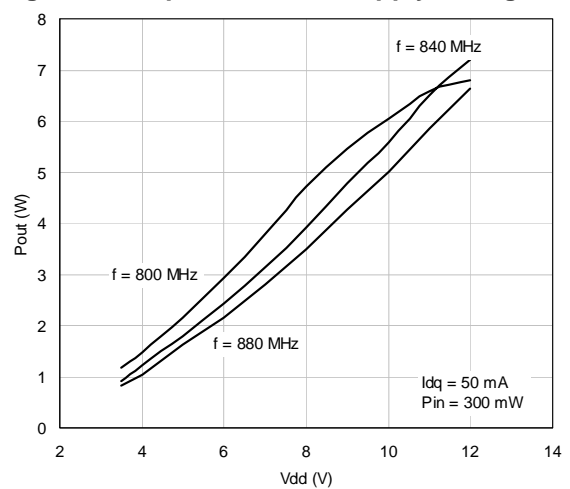

Figure 9. Test Circuit

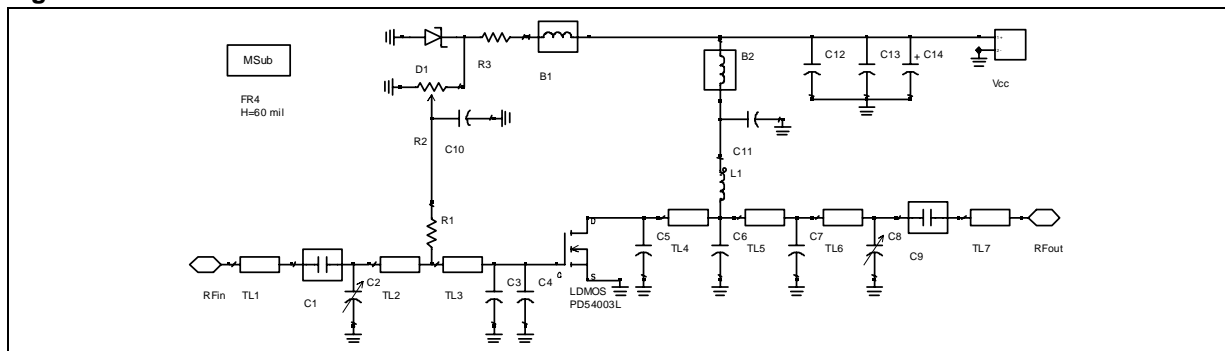

Table 4. Component Part List

Component ID	Description	Value	Case size	Manufacturer	Part Code
C1, C9	Capacitor	30 pF	100B	ATC	3R0
C2, C8	Variable Capacitor	0.8 :- 8 pF		Johnson	27293
C3	Capacitor	4.3 pF	100B	ATC	4R3
C4, C5	Capacitor	18 pF	100B	ATC	180
C6	Capacitor	9.1 pF	100B	ATC	9R1
C7	Capacitor	8.2 pF	100B	ATC	8R2
C10	Capacitor	120 pF	1206	Murata	GRM42-6C0G121J50
C11	Capacitor	120 pF	1206	Murata	GRM42-6C0G121J50
C12	Capacitor	1 nF	1206	Murata	GRM42-6C0G102J50
C13	Capacitor	10 nF	1206	Murata	GRM42-6X7R104K50
C14	Capacitor	10 uF	SMT	Panasonic	EEVHB1V100P
L1	Inductor	35.5 nH		Coilcraft	B09T
B1	Ferrite Bead			PANASONIC	EXCELDRC35C
B2	Ferrite Bead			PANASONIC	EXCELDRC35C
R1	Resistor	15	1206	TYCO ELECTRONICS	01623429-1
R2	Potentiometer	10 K		BOURNS ELECTRONICS	3214W-1-103E
R3	Resistor	1 K	1206	TYCO ELECTRONICS	01623440-1
D1	Zener Diode	5.1 V	SOD110	PHILIPS	BZX284C5V1
TL1	Transmission Line	-	W = 2.87 mm, L = 8.6 mm		
TL2	Transmission Line	-	W = 2.87 mm, L = 12.7 mm		
TL3, TL4	Transmission Line	-	W = 4.9 mm, L = 5.8 mm		
TL5	Transmission Line	-	W = 2.87 mm, L = 2 mm		

TL6	Transmission Line	-	W = 2.87 mm, L = 10 mm		
TL7	Transmission Line	-	W = 2.87 mm, L = 7.5 mm		
RF in	SMA-CONN			Johnson	142-0701-801
RF out	SMA-CONN			Johnson	142-0701-801
PD54003L	LDMOS			STMicroelectronics	PD54003L

Figure 10. Photomaster

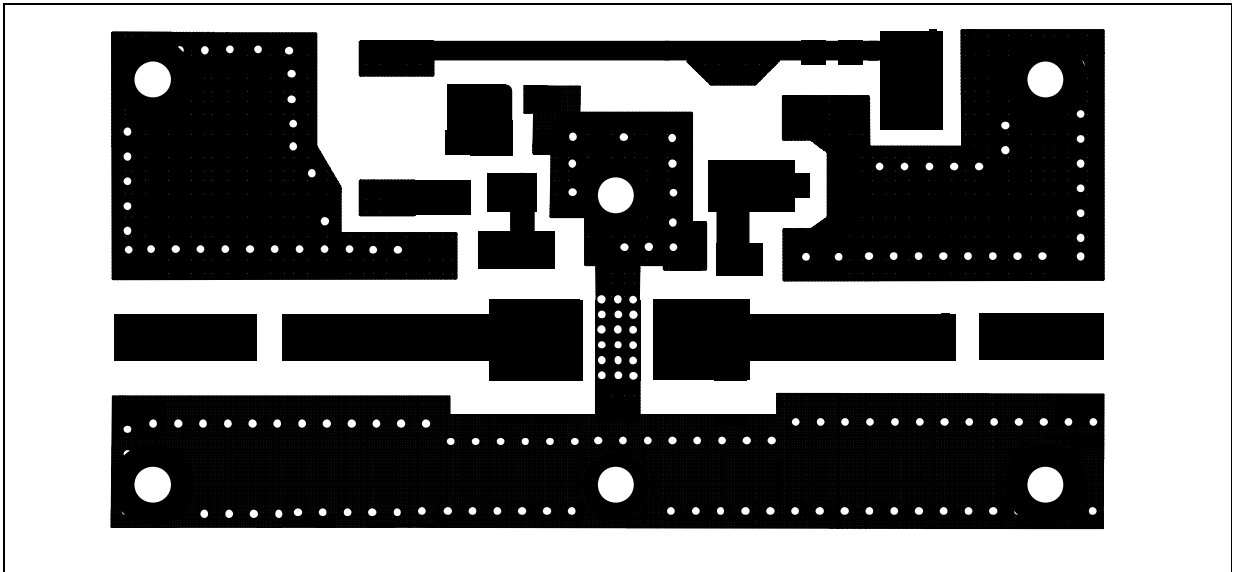
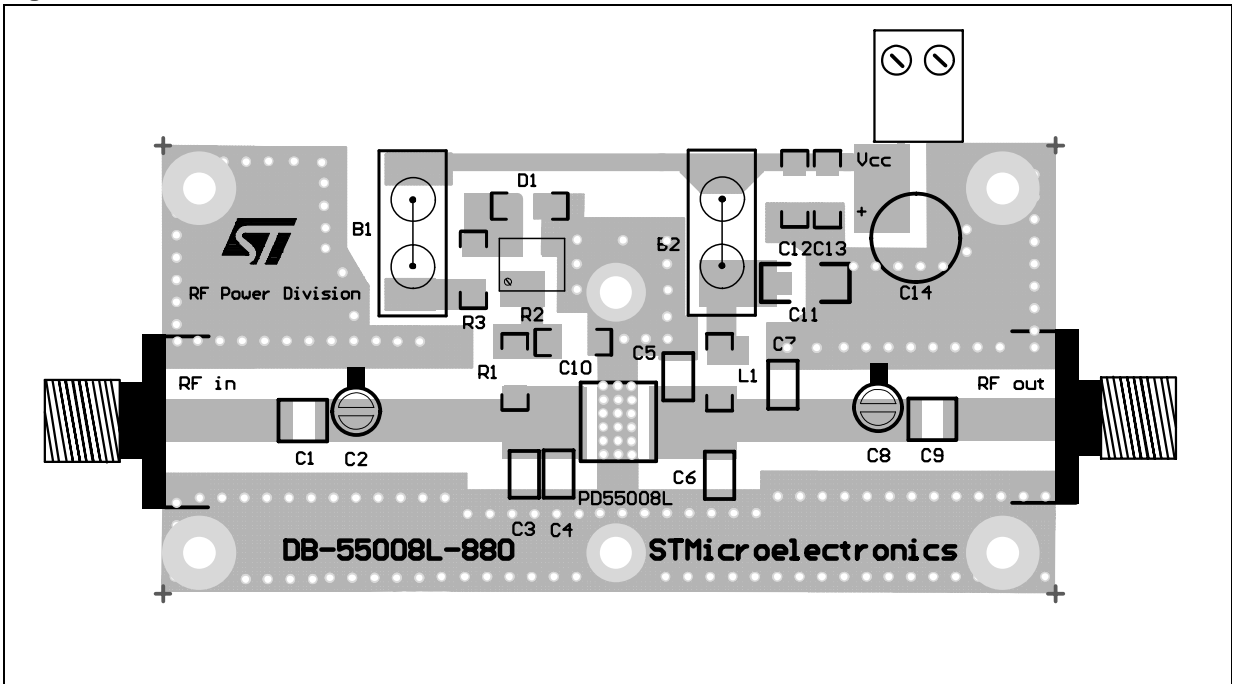

Figure 11. Circuit



**TAPE & REEL**

**Table 5. PowerFLAT™ Tape & Reel Dimensions**

DIM.	mm.		
	MIN.	TYP	MAX.
Ao	5.15	5.25	5.35
Bo	5.15	5.25	5.35
Ko	1.0	1.1	1.2

**Figure 12. PowerFLAT™ Tape & Reel**

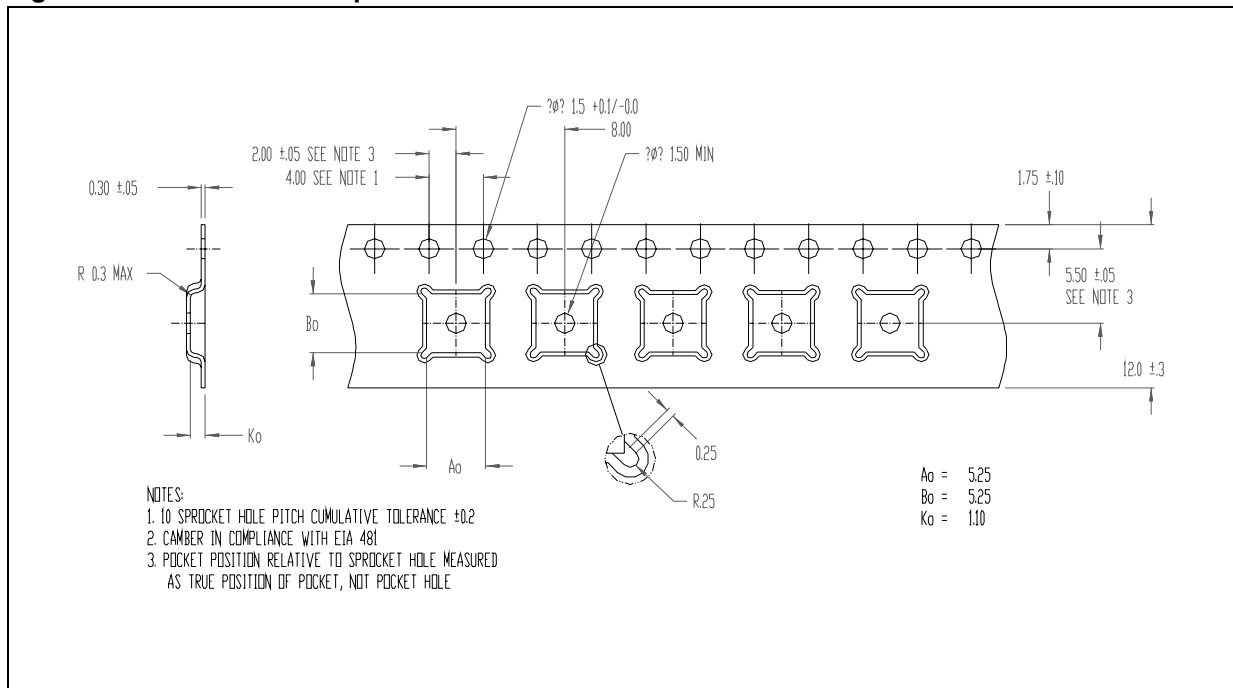

MOUNTING INDICATIONS

Figure 13. Standard SMD Mounting

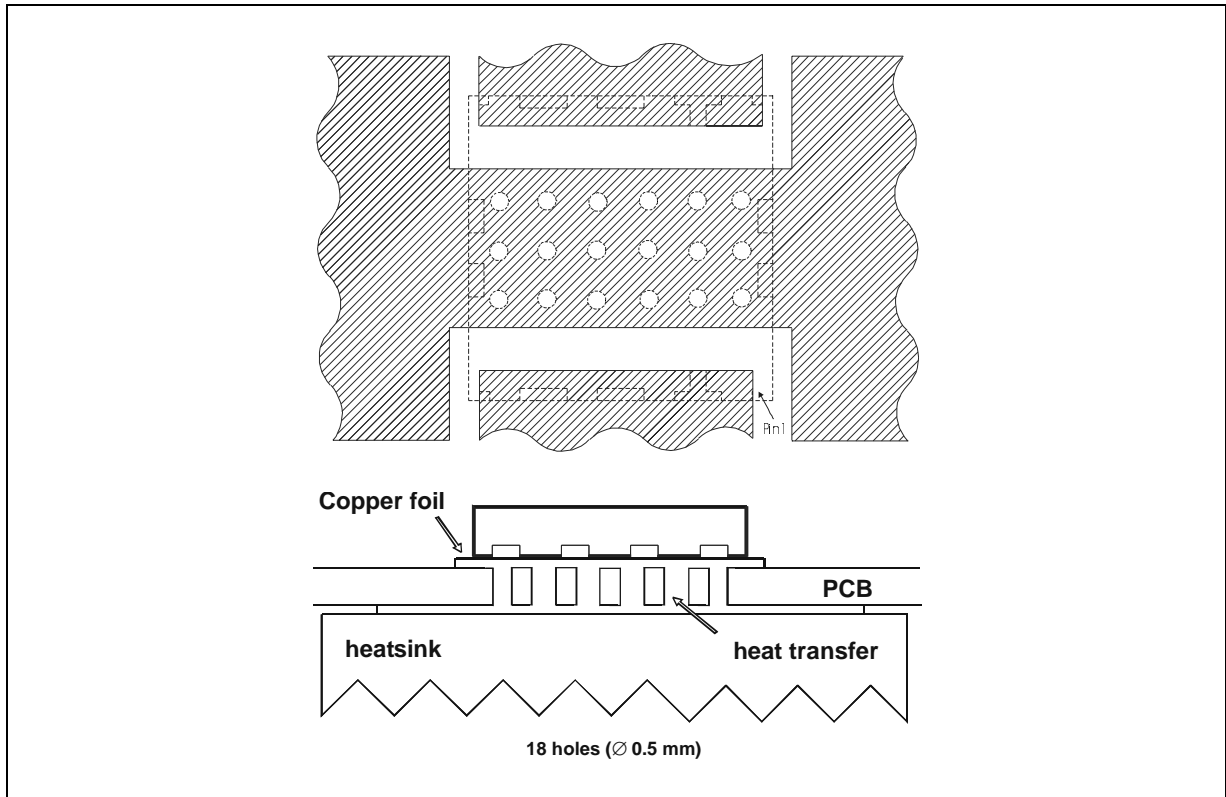



## PACKAGE MECHANICAL

Table 6. PowerFLAT™ Mechanical Data

DIM.	mm			inch		
	MIN.	TYP	MAX.	MIN.	TYP	MAX.
A		0.90	1.00		0.035	0.039
A1		0.02	0.05		0.001	0.002
A3		0.24			0.009	
AA	0.15	0.25	0.35	0.006	0.01	0.014
b	0.43	0.51	0.58	0.017	0.020	0.023
c	0.64	0.71	0.79	0.025	0.028	0.031
D		5.00			0.197	
d		0.30			0.011	
E		5.00			0.197	
E2	2.49	2.57	2.64	0.098	0.101	0.104
e		1.27			0.050	
f		3.37			0.132	
g		0.74			0.03	
h		0.21			0.008	

Figure 14. PowerFLAT™ Package Dimensions

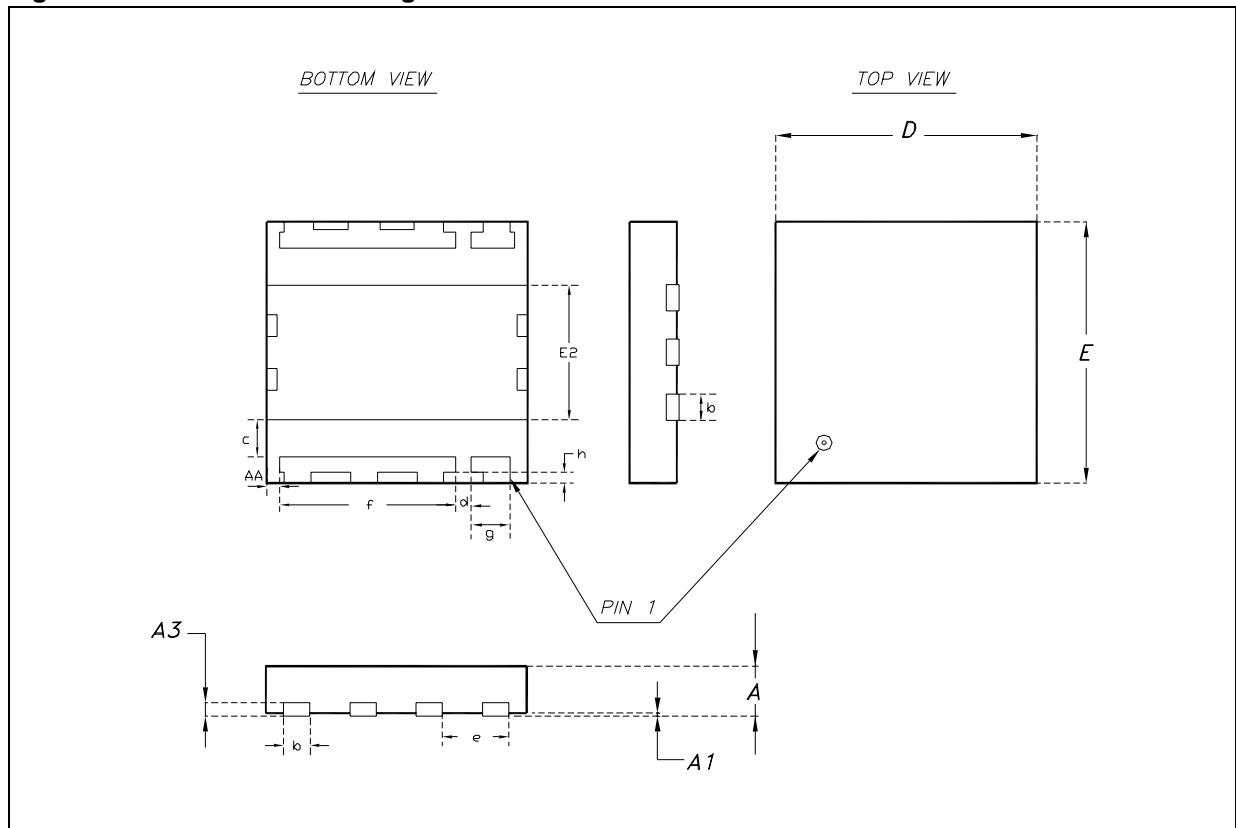

**REVISION HISTORY**

**Table 7. Revision History**

<b>Date</b>	<b>Revision</b>	<b>Description of Changes</b>
11-Nov-2005	1	First Issue.

Information furnished is believed to be accurate and reliable. However, STMicroelectronics assumes no responsibility for the consequences of use of such information nor for any infringement of patents or other rights of third parties which may result from its use. No license is granted by implication or otherwise under any patent or patent rights of STMicroelectronics. Specifications mentioned in this publication are subject to change without notice. This publication supersedes and replaces all information previously supplied. STMicroelectronics products are not authorized for use as critical components in life support devices or systems without express written approval of STMicroelectronics.

The ST logo is a registered trademark of STMicroelectronics.  
All other names are the property of their respective owners

© 2005 STMicroelectronics - All rights reserved

STMicroelectronics group of companies

Australia - Belgium - Brazil - Canada - China - Czech Republic - Finland - France - Germany - Hong Kong - India - Israel - Italy - Japan -  
Malaysia - Malta - Morocco - Singapore - Spain - Sweden - Switzerland - United Kingdom - United States of America

[www.st.com](http://www.st.com)

